

81/07/11/11 pe-stey

Karlstad III/40/18

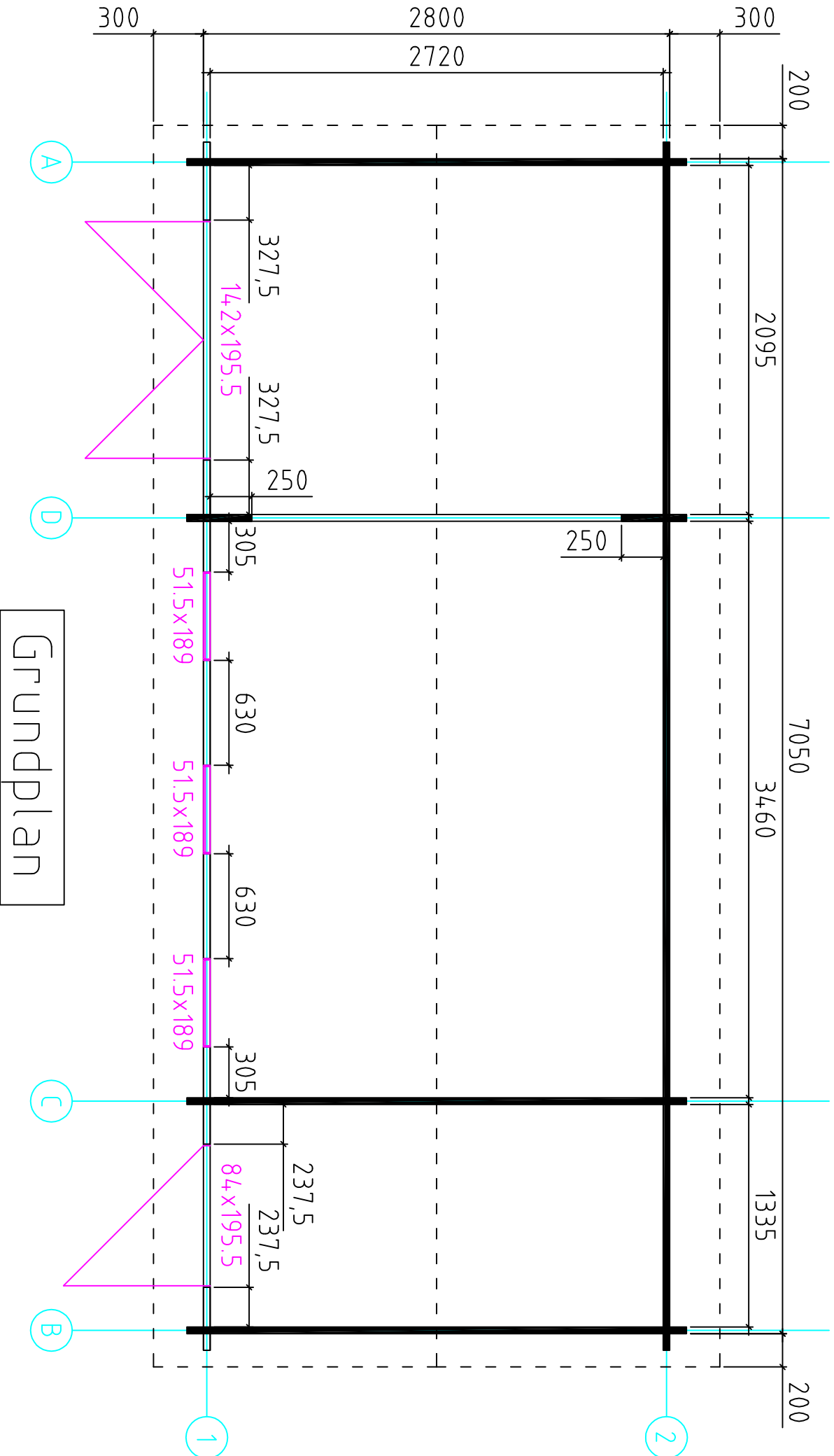

Grundplan

Karlstad 111/40/18

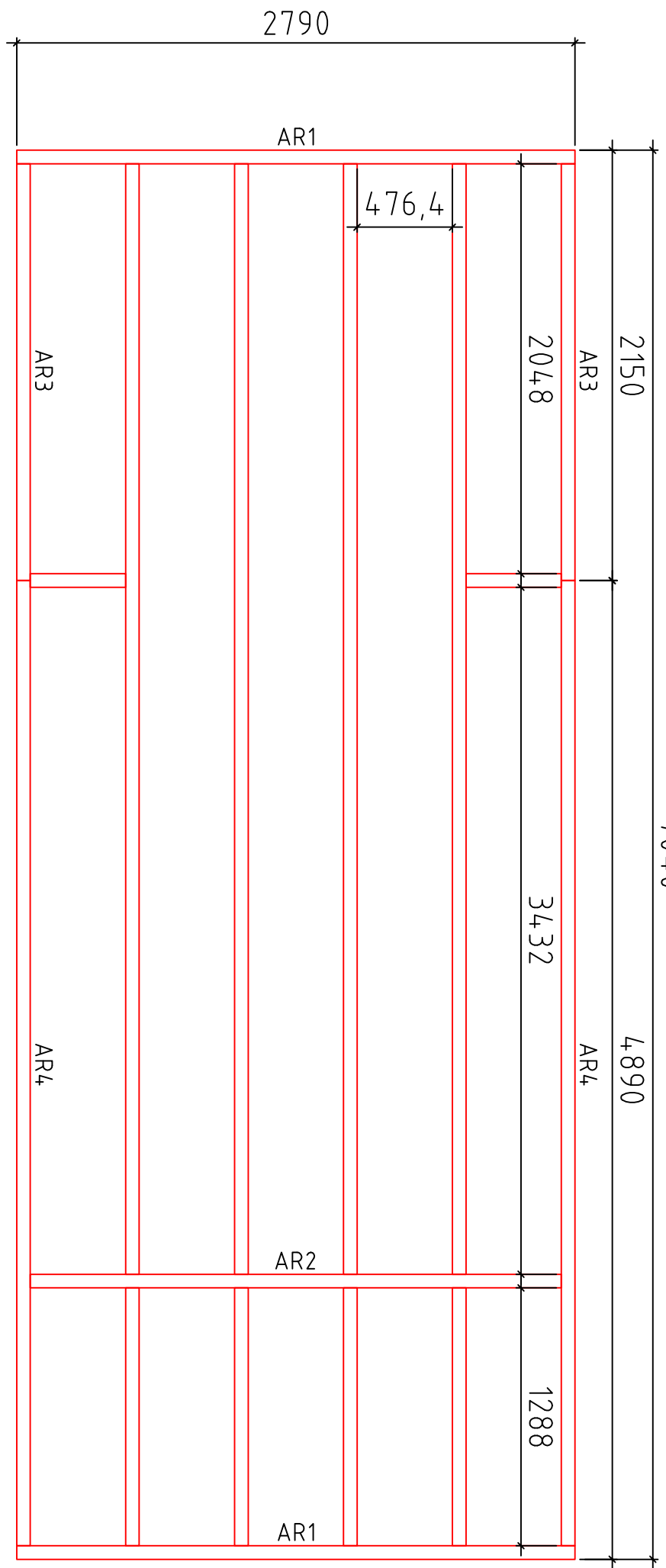

Fundament

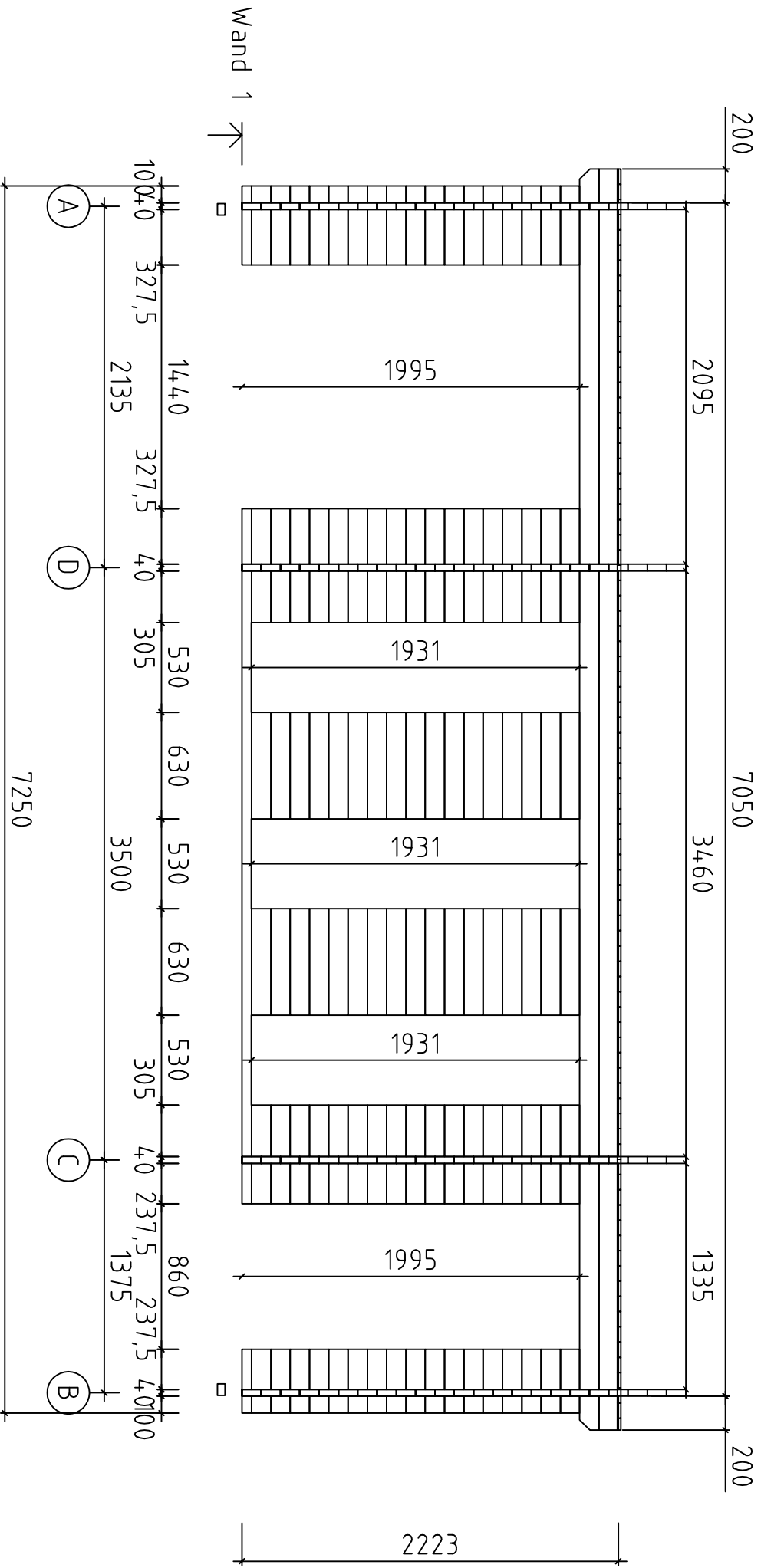

Karlstad 11/40/18

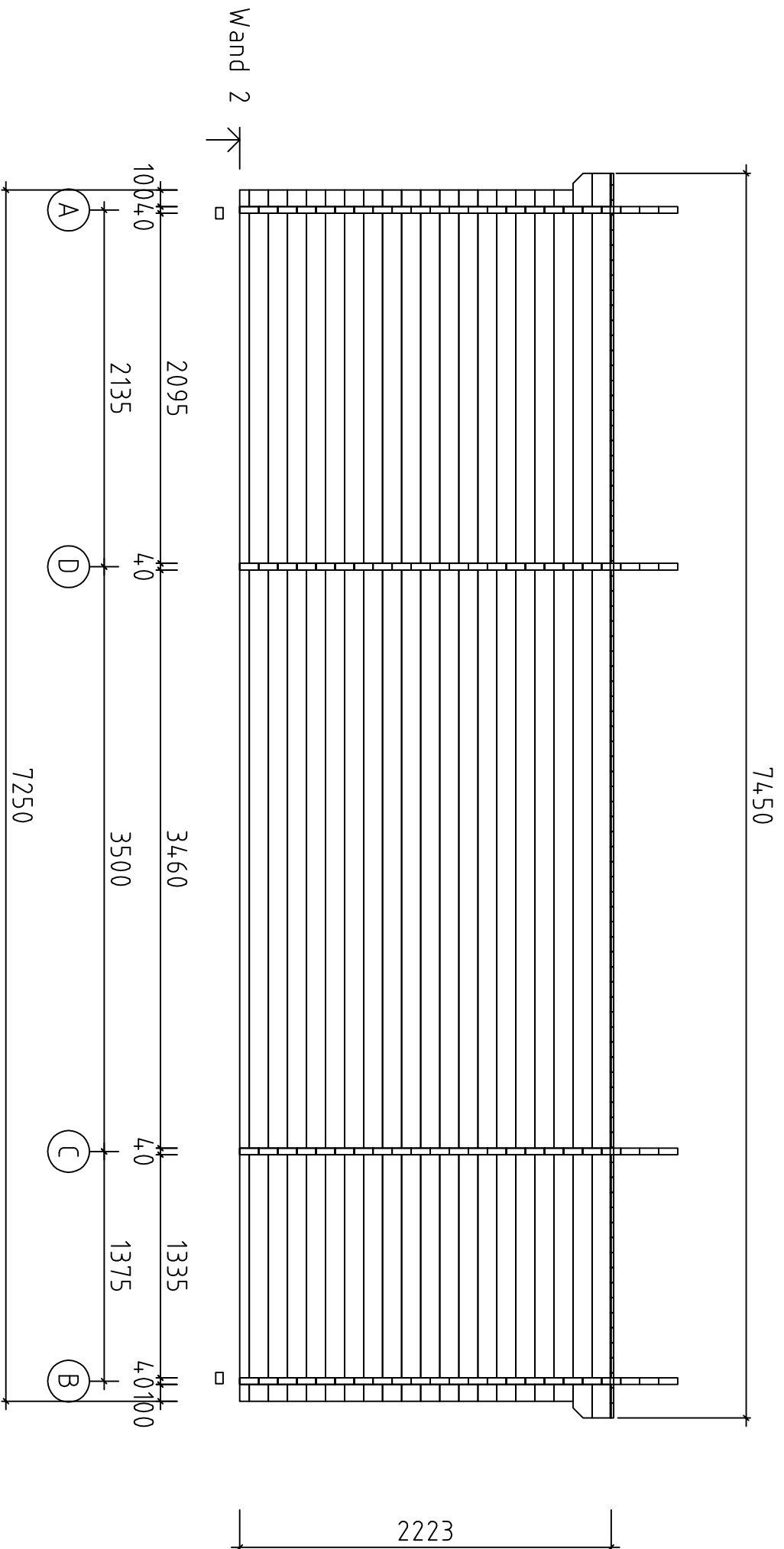

Karlstad 111/40/18

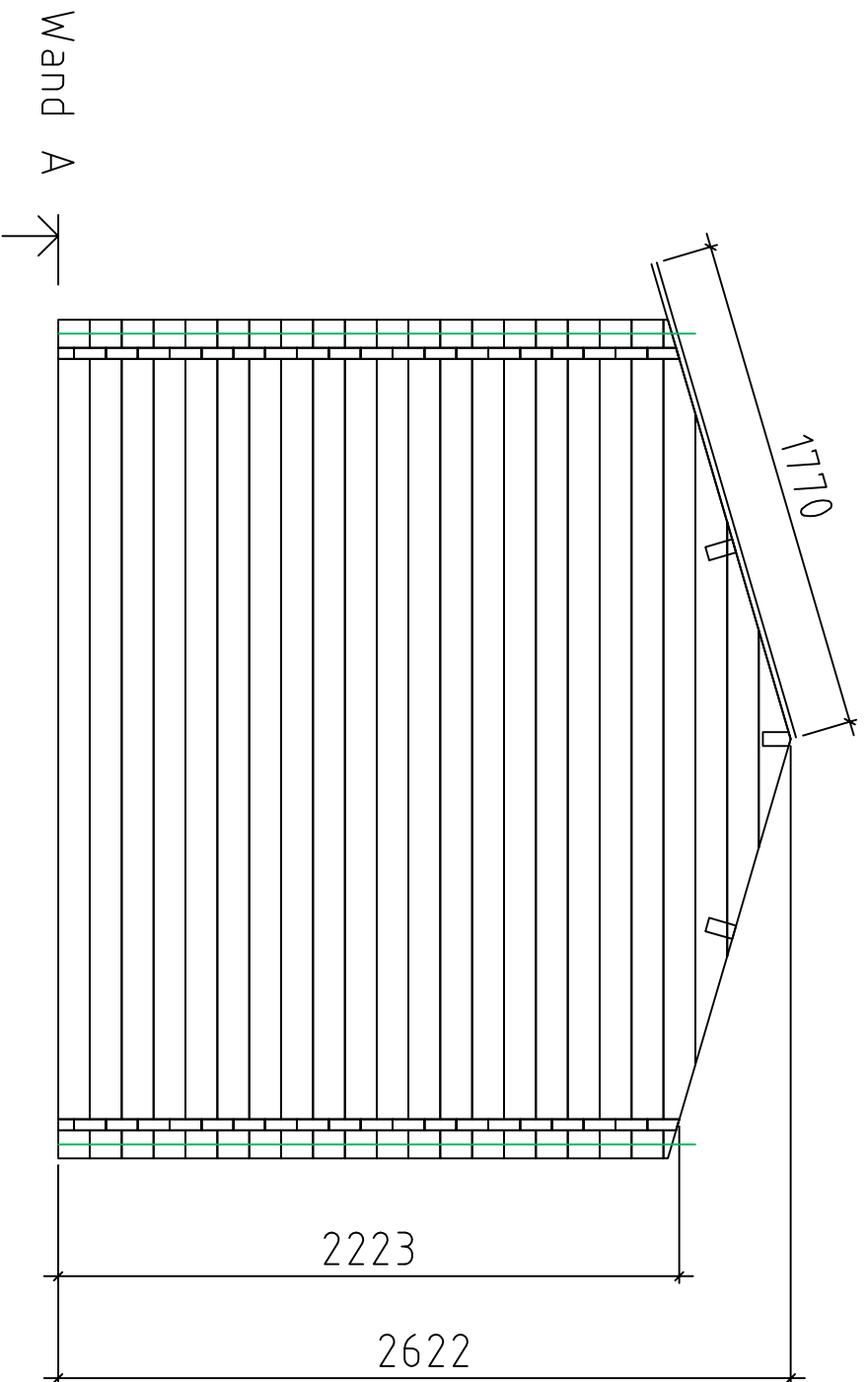

Karlstad 111/40/18

Wand B

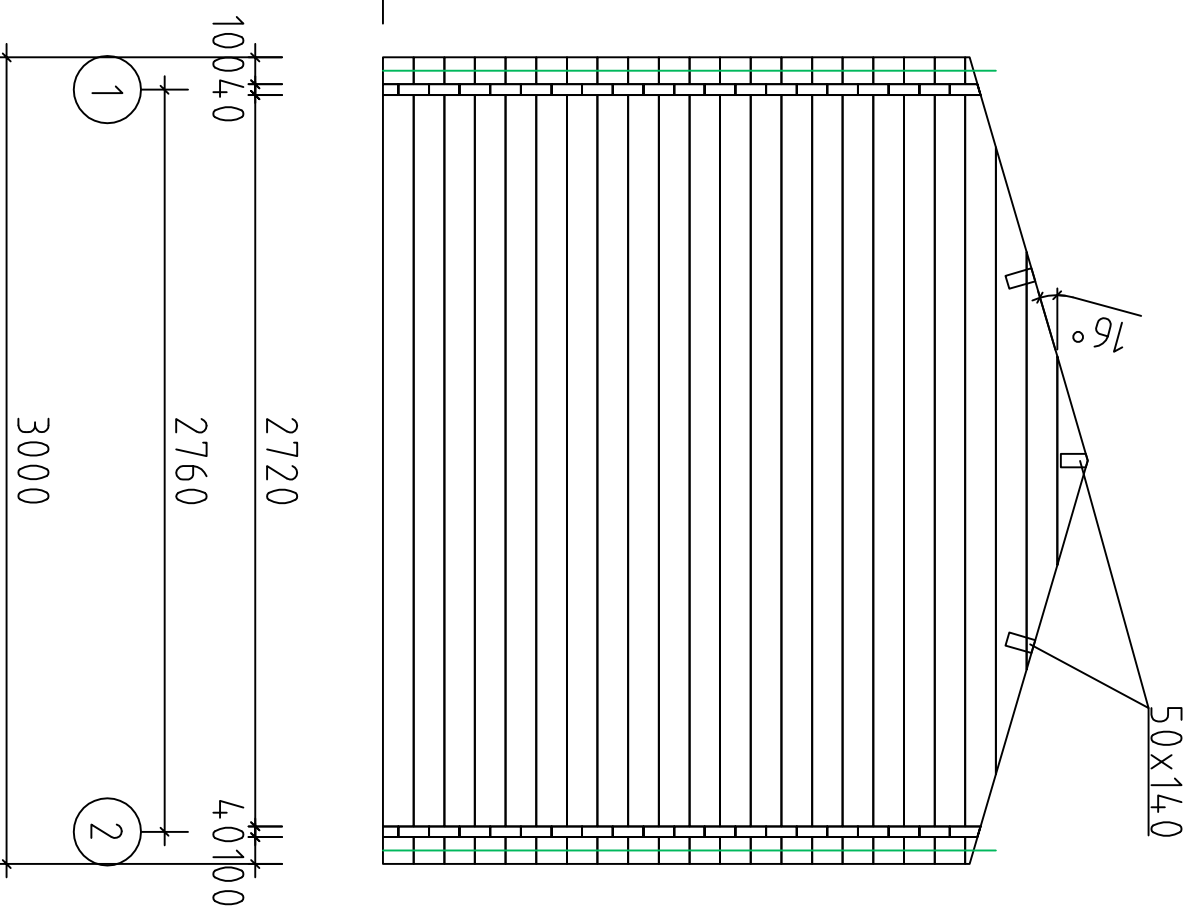

Karlstad 111/40/18

Wand C ↗

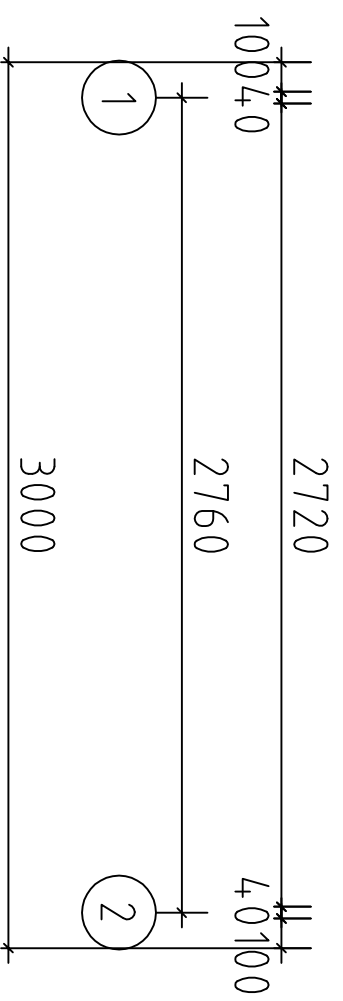
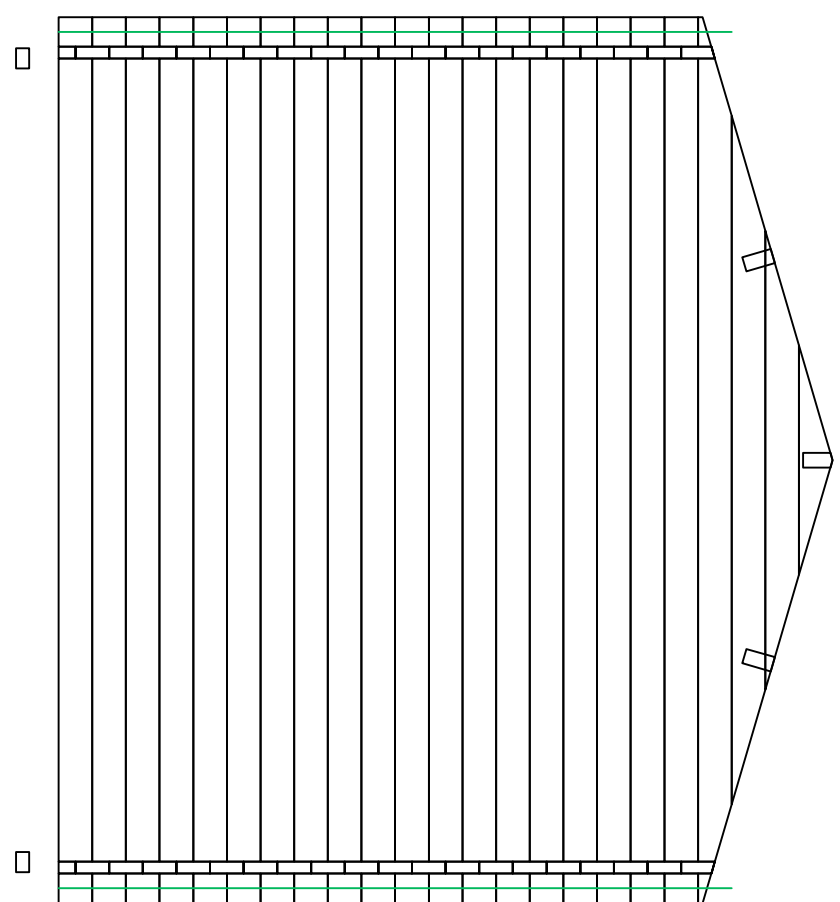

Karlstad 111/40/18

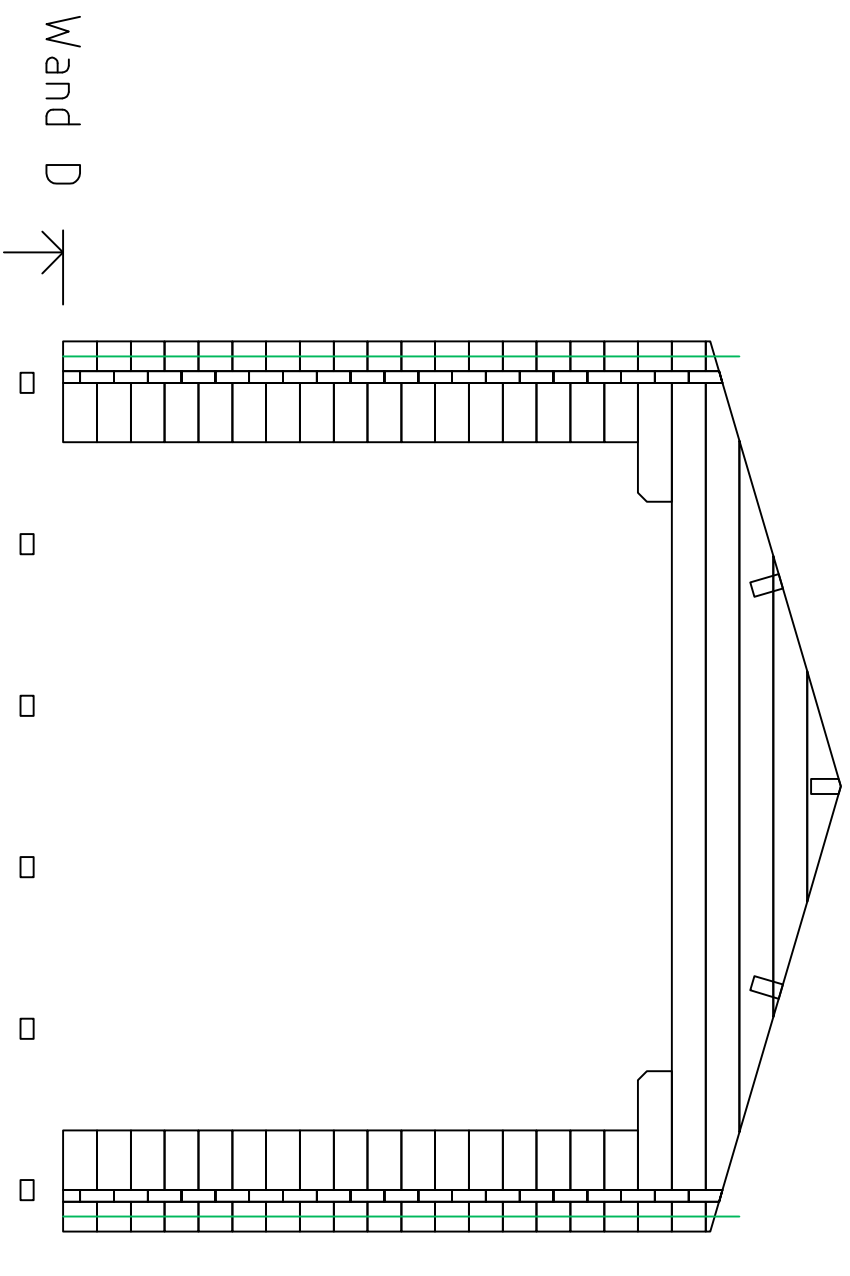

1

2

Karlstad 111/40/18

AB

Tür 1420x1955 (Leng!!)

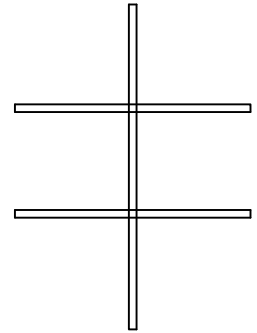
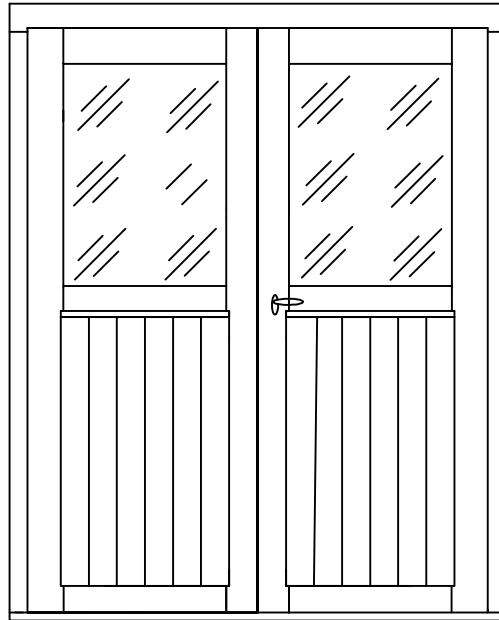
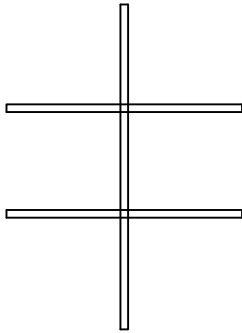

AB

Tür 840x1900 (Leng)

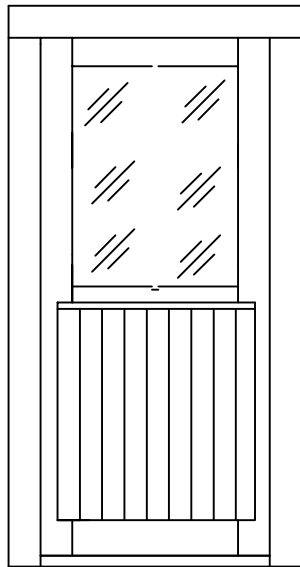
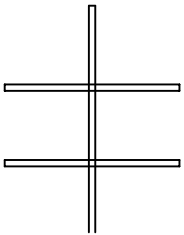

Fenster 515x1890
(Leng)

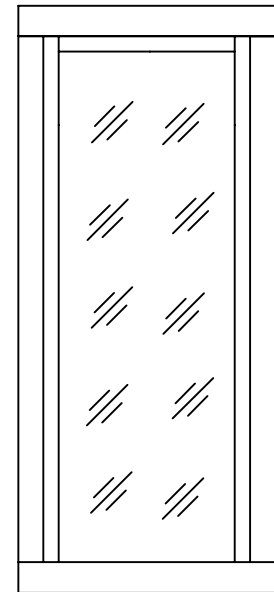

Karlstad I///40/18